



# Plastic Stents

PANCREATIC AND BILIARY



AORTIC  
INTERVENTION

CRITICAL  
CARE

ENDOSCOPY

INTERVENTIONAL  
RADIOLOGY

LEAD  
MANAGEMENT

PERIPHERAL  
INTERVENTION

SURGERY

UROLOGY

WOMEN'S  
HEALTH

# Guide to Order Information

	3 FR	4 FR	5 FR	6 FR	7 FR
2 cm	GPSO-3-2 G27105	GPSO-4-2 G27106	GPSO-5-2 G22434	GPSO-6-2 G22467	GPSO-7- G22379
3 cm	GPSO-3-3 G27190		GPSO-5-3 G22107	GPSO-6-3 G22410	GPSO-7-3 G21371
4 cm	GPSO-3-4 G24543		GPSO-5-4 G22110		GPSO-7-4 G21373
5	GPSO-3-5	GPSO-4-5	GPSO-5-5 G22111	GPSO-6-5 G22411	GPSO-7-5 G21374

**French Size**

**Color Connection**

- Purple accepts .035" wire guide
- Blue accepts .025" wire guide
- Black accepts .021" wire guide
- Green accepts .018" wire guide

**Length**

**Order Number**

**Global Part Number (GPN)**

**Stock**

**Nonstock**



# Cotton-Huibregtse<sup>®</sup>

BILIARY STENT

Shaping the future of biliary drainage, this plastic stent is distinguished by its anatomical design, which enhances positioning in the bile duct.

- Anatomical shape for enhanced positioning
- Tapered tip facilitates smooth cannulation
- Proximal and distal flaps help minimize migration
- Polyethylene material delivers pushability and softness
- Simplify inventory management and enhance procedural efficiency with stent sets, including pushing and guiding catheters



# Cotton-Huibregtse Biliary Stents

	7 FR	8.5 FR	10 FR	11.5 FR
3 cm			CHBSO-10-3 G21648	
4 cm	CHBSO-7-4 G21719		CHBSO-10-4 G21650	
5 cm	CHBSO-7-5 G21720	CHBSO-8.5-5 G21699	CHBSO-10-5 G21652	CHBSO-11.5-5 G21797
6 cm			CHBSO-10-6 G21654	
7 cm	CHBSO-7-7 G21721	CHBSO-8.5-7 G21700	CHBSO-10-7 G21656	CHBSO-11.5-7 G21799
8 cm			CHBSO-10-8 G21657	CHBSO-11.5-8 G21800
9 cm	CHBSO-7-9 G21722	CHBSO-8.5-9 G21702	CHBSO-10-9 G21658	CHBSO-11.5-9 G21801
10 cm	CHBSO-7-10 G22211	CHBSO-8.5-10 G22195	CHBSO-10-10 G21879	CHBSO-11.5-10 G22197
11 cm			CHBSO-10-11 G21880	
12 cm	CHBSO-7-12 G22213	CHBSO-8.5-12 G22196	CHBSO-10-12 G21881	CHBSO-11.5-12 G22199
15 cm	CHBSO-7-15 G22217	CHBSO-8.5-15 G22198	CHBSO-10-15 G21883	CHBSO-11.5-15 G22200
18 cm	CHBSO-7-18 G27172	CHBSO-8.5-18 G27173	CHBSO-10-18 G22404	CHBSO-11.5-18 G27171

Components available separately.

## CHBSO

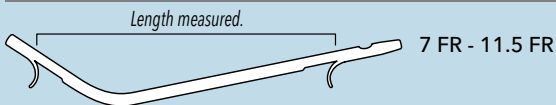

	7 FR	8.5 FR	10 FR	11.5 FR
3 cm	CHBS-7-3 G22486		CHBS-10-3 G21454	
5 cm	CHBS-7-5 G21831	CHBS-8.5-5 G21814	CHBS-10-5 G21455	CHBS-11.5-5 G21541
6 cm	CHBS-7-6 G22485			
7 cm	CHBS-7-7 G21832	CHBS-8.5-7 G21817	CHBS-10-7 G21457	CHBS-11.5-7 G21542
9 cm	CHBS-7-9 G21834	CHBS-8.5-9 G21820	CHBS-10-9 G21459	CHBS-11.5-9 G21545
10 cm	CHBS-7-10 G22420		CHBS-10-10 G21996	CHBS-11.5-10 G22118
11 cm			CHBS-10-11 G21997	
12 cm	CHBS-7-12 G21970	CHBS-8.5-12 G21888	CHBS-10-12 G21999	CHBS-11.5-12 G22121
15 cm	CHBS-7-15 G21971	CHBS-8.5-15 G21889	CHBS-10-15 G22000	CHBS-11.5-15 G22123

Set Includes: Stent, 170 cm pushing catheter and 320 cm guiding catheter. 7 FR stents do not include guiding catheter. Components available separately.

## CHBS

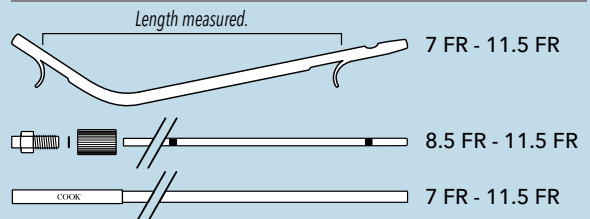

**COOK** MEDICAL **Cotton-Leung**<sup>®</sup>  
BILIARY STENT

The subtle, natural curve of the Cotton-Leung Biliary Stent enhances its introduction and positioning capabilities, making it the stent of choice for a variety of clinical needs.

- Available in the widest range of sizes of any stent
- Gentle curved shape adapts to bile duct
- Tapered tip for smooth cannulation
- Proximal and distal flaps help minimize migration
- Polyethylene material delivers pushability and softness
- Simplify inventory management and enhance procedural efficiency with stent sets, including pushing and guiding catheters



**Cotton-Leung Biliary Stents**

	5 FR	7 FR	8.5 FR	10 FR	11.5 FR
2 cm		CLSO-7-2 G22392		CLSO-10-2 G21463	
3 cm	CLSO-5-3 G22383	<b>CLSO-7-3</b> <b>G21679</b>	CLSO-8.5-3 G21617	CLSO-10-3 G21464	CLSO-11.5-3 G21639
4 cm		CLSO-7-4 G21680		CLSO-10-4 G21465	
5 cm	CLSO-5-5 G21565	CLSO-7-5 G21681	CLSO-8.5-5 G21619	CLSO-10-5 G22622	CLSO-11.5-5 G21643
6 cm		CLSO-7-6 G27143	CLSO-8.5-6 G27148	CLSO-10-6 G21467	CLSO-11.5-6 G27141
7 cm	CLSO-5-7 G22384	CLSO-7-7 G21683	CLSO-8.5-7 G21620	CLSO-10-7 G21469	CLSO-11.5-7 G21646
8 cm		CLSO-7-8 G21684	CLSO-8.5-8 G22343	CLSO-10-8 G21472	CLSO-11.5-8 G27104
9 cm		CLSO-7-9 G21685	CLSO-8.5-9 G21621	CLSO-10-9 G21474	CLSO-11.5-9 G21647
10 cm		CLSO-7-10 G21979	CLSO-8.5-10 G22009	CLSO-10-10 G21807	CLSO-11.5-10 G21761
11 cm		CLSO-7-11 G21981	CLSO-8.5-11 G27145	CLSO-10-11 G21808	CLSO-11.5-11 G27103
12 cm	CLSO-5-12 G22398	CLSO-7-12 G21983	CLSO-8.5-12 G22011	CLSO-10-12 G21810	CLSO-11.5-12 G27140
13 cm		CLSO-7-13 G21984	CLSO-8.5-13 G27146	CLSO-10-13 G21811	CLSO-11.5-13 G31508
14 cm		CLSO-7-14 G21987	CLSO-8.5-14 G27147	CLSO-10-14 G21812	CLSO-11.5-14 G21763
15 cm	CLSO-5-15 G22399	CLSO-7-15 G21988	CLSO-8.5-15 G22012	CLSO-10-15 G21813	CLSO-11.5-15 G21764
16 cm		CLSO-7-16 G27142	CLSO-8.5-16 G22709	CLSO-10-16 G21815	CLSO-11.5-16 G21766
17 cm		CLSO-7-17 G22480	CLSO-8.5-17 G22710	CLSO-10-17 G21816	CLSO-11.5-17 G22400
18 cm		CLSO-7-18 G21990	CLSO-8.5-18 G22711	CLSO-10-18 G21818	CLSO-11.5-18 G21767

# Cotton-Leung Biliary Stents continued

	5 FR	7 FR	8.5 FR	10 FR	11.5 FR
19 cm		CLSO-7-19 G21991		CLSO-10-19 G22479	
20 cm		CLSO-7-20 G21993	CLSO-8.5-20 G22712	CLSO-10-20 G21821	CLSO-11.5-20 G22713
21 cm		CLSO-7-21 G24784		CLSO-10-21 G24785	

Introducer components available separately.

	5 FR	7 FR	8.5 FR	10 FR	11.5 FR
3 cm		CLBS-7-3 G21947	CLBS-8.5-3 G21487	CLBS-10-3 G21841	CLBS-11.5-3 G22051
4 cm		CLBS-7-4 G21949		CLBS-10-4 G21843	
5 cm	CLBS-5-5 G22402	CLBS-7-5 G21950	CLBS-8.5-5 G21489	CLBS-10-5 G21844	CLBS-11.5-5 G22052
6 cm		CLBS-7-6 G21951	CLBS-8.5-6 G21490	CLBS-10-6 G27124	CLBS-11.5-6 G22054
7 cm	CLBS-5-7 G22278	CLBS-7-7 G21952	CLBS-8.5-7 G21492	CLBS-10-7 G21847	CLBS-11.5-7 G22056
8 cm		CLBS-7-8 G27135	CLBS-8.5-8 G21495	CLBS-10-8 G21848	CLBS-11.5-8 G22057
9 cm	CLBS-5-9 G22403	CLBS-7-9 G21954	CLBS-8.5-9 G21496	CLBS-10-9 G21850	CLBS-11.5-9 G22059
10 cm		CLBS-7-10 G21563	CLBS-8.5-10 G21598	CLBS-10-10 G21668	CLBS-11.5-10 G27125
11 cm		CLBS-7-11 G27130	CLBS-8.5-11 G27136	CLBS-10-11 G27121	CLBS-11.5-11 G22053
12 cm	CLBS-5-12 G22414	CLBS-7-12 G21566	CLBS-8.5-12 G21599	CLBS-10-12 G21670	CLBS-11.5-12 G22055
13 cm		CLBS-7-13 G27131	CLBS-8.5-13 G27137	CLBS-10-13 G21672	CLBS-11.5-13 G27126
14 cm		CLBS-7-14 G27132	CLBS-8.5-14 G27138	CLBS-10-14 G27122	CLBS-11.5-14 G27127
15 cm		CLBS-7-15 G21569	CLBS-8.5-15 G21600	CLBS-10-15 G21673	CLBS-11.5-15 G22060
16 cm		CLBS-7-16 G27133	CLBS-8.5-16 G24648	CLBS-10-16 G27123	CLBS-11.5-16 G27128
17 cm		CLBS-7-17 G27134	CLBS-8.5-17 G24649	CLBS-10-17 G21674	CLBS-11.5-17 G27129
18 cm		CLBS-7-18 G21574	CLBS-8.5-18 G27139	CLBS-10-18 G21675	CLBS-11.5-18 G22064

Set Includes: Stent, 170 cm pushing catheter and 320 cm guiding catheter. 5 and 7 FR stents do not include guiding catheter. Components available separately.

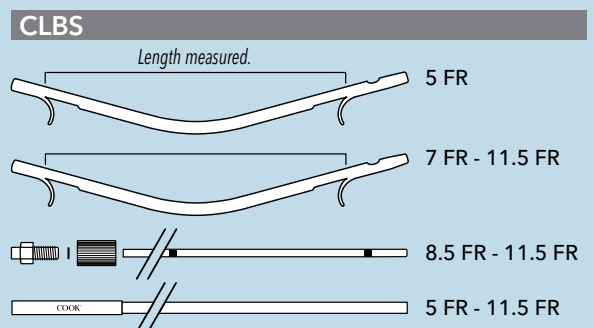
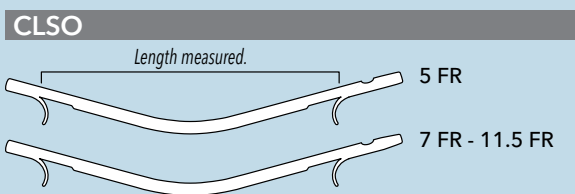

## BILIARY

**COOK**  
MEDICAL

# Cotton-Leung<sup>®</sup>

SOF-FLEX<sup>®</sup> BILIARY STENT

Soft on tissue, strong on results. Naturally curved and made of a pliable material, the Cotton-Leung Sof-Flex Biliary Stent is designed for improved introduction and positioning capabilities.

- Sof-Flex is a “soft” pliable radiopaque material that enhances fluoroscopic visibility
- Available in a variety of sizes to meet patients’ needs
- Gentle curved shape adapts to bile duct
- Tapered tip for smooth cannulation
- Proximal and distal flaps help minimize migration

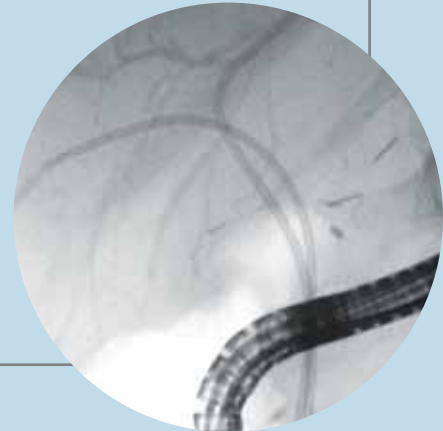
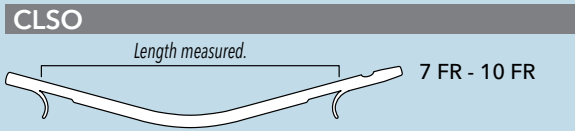

*Image courtesy of Martin Freeman, M.D., University of Minnesota Medical Center, Minneapolis, MN*

# Cotton-Leung Sof-Flex Biliary Stents

	7 FR	10 FR
5 cm	CLSO-SF-7-5 G49658	CLSO-SF-10-5 G49653
7 cm	CLSO-SF-7-7 G49659	CLSO-SF-10-7 G49654
9 cm	CLSO-SF-7-9 G49660	CLSO-SF-10-9 G49655
12 cm	CLSO-SF-7-12 G49661	CLSO-SF-10-12 G49656
15 cm	CLSO-SF-7-15 G49662	CLSO-SF-10-15 G49657

*Components available separately.*





## BILIARY



# Fusion<sup>®</sup> Marathon<sup>®</sup>

ANTI-REFLUX BILIARY STENT

The next solution for biliary occlusion. The Marathon Anti-Reflux Biliary Stent is the only stent that offers an anti-reflux valve for reduced duodenal reflux and potentially increased bile flow.

- Unique valve permits closure by duodenal pressure, facilitates opening under bile flow
- Valve maintains antegrade flow of bile due to bile pressure and may even be increased due to a siphon effect
- Significant reduction in retrograde flow of fluid and fibers

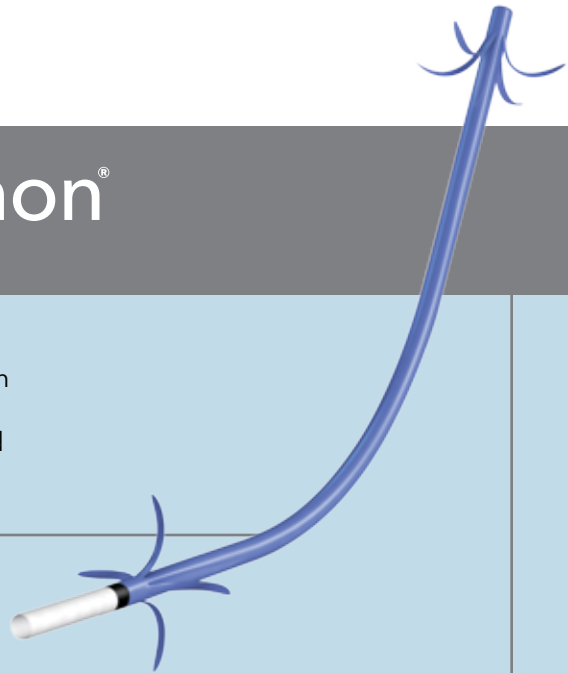

*Image courtesy of Kulwinder Dua, M.D., Medical College of Wisconsin, Milwaukee, WI*

# Fusion Marathon Anti-Reflux Biliary Stents

10 FR

5 cm	FS-MAR-10-5 G49142
6 cm	FS-MAR-10-6 G49143
7 cm	FS-MAR-10-7 G49144
8 cm	FS-MAR-10-8 G49145
9 cm	FS-MAR-10-9 G49146
10 cm	FS-MAR-10-10 G49147
11 cm	FS-MAR-10-11 G49148
12 cm	FS-MAR-10-12 G49149

## FS-MAR

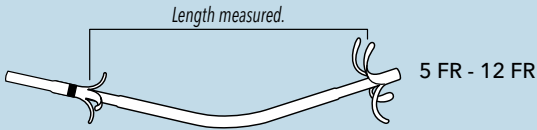



# Fusion<sup>®</sup>OASIS<sup>®</sup>

ONE ACTION STENT INTRODUCTION SYSTEM

Streamline plastic stenting procedures with Fusion OASIS. Accurately reposition or remove plastic stents while maintaining a secure wire guide, reducing procedural steps and saving valuable time.

- Fusion capability allows plastic stents to be repositioned, recaptured before deployment or removed entirely while maintaining ductal access
- Compatible with a wide array of our exceptional plastic stents
- Deliver multiple stents without recannulation, reducing procedural steps

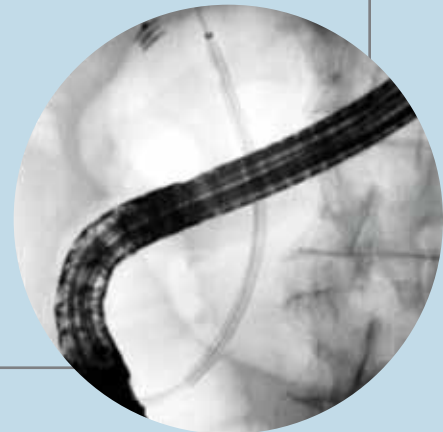

# Fusion OASIS

	8.5 FR	10 FR
--	--------	-------

	FS-OA-8.5 G31526	FS-OA-10 G31527
--	---------------------	--------------------

4.2 mm minimum accessory channel. Not for use with pigtail stents.

# Fusion Pushing Catheter

	5 FR	7 FR
--	------	------

	FS-PC-5 G31550	FS-PC-7 G31551
--	-------------------	-------------------

3.2 mm minimum accessory channel.

## FS-OA

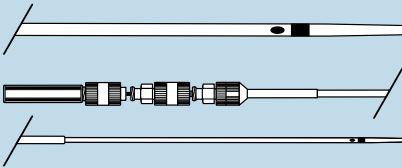

## FS-PC

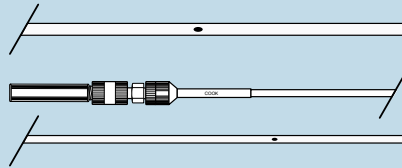

## BILIARY



# OASIS<sup>®</sup>

ONE ACTION STENT INTRODUCTION SYSTEM

Whether you choose a pre-loaded Cotton-Leung Stent or ST-2 Soehendra-Tannenbaum, Cook's OASIS One Action Stent Introduction System delivers fast, efficient stent placement that can streamline your plastic stenting procedures.

- Single-step delivery enhances efficiency and saves time
- Preloaded with Cotton-Leung or ST-2 Soehendra-Tannenbaum stents to maximize efficiency
- Radiopaque bands on introducer enhance fluoroscopic visualization during placement
- Tapered guiding catheter dilates stricture prior to stent placement



*Image courtesy of Michael Kimmey, M.D., Tacoma Digestive Disease Center, Tacoma, WA*

# OASIS

preloaded with Cotton-Leung  
Biliary Stents

	7 FR	8.5 FR	10 FR	11.5 FR
5 cm	OACL-7-5 G25656	OACL-8.5-5 G25374	OACL-10-5 G25379	OACL-11.5-5 G25384
7 cm	OACL-7-7 G25657	OACL-8.5-7 G25375	OACL-10-7 G25380	OACL-11.5-7 G25385
9 cm	OACL-7-9 G25658	OACL-8.5-9 G25376	OACL-10-9 G25381	OACL-11.5-9 G25386
12 cm	OACL-7-12 G25659	OACL-8.5-12 G25377	OACL-10-12 G25382	OACL-11.5-12 G25387
15 cm	OACL-7-15 G25660	OACL-8.5-15 G25378	OACL-10-15 G25383	OACL-11.5-15 G25388

Components available separately.

## OACL

Length measured.

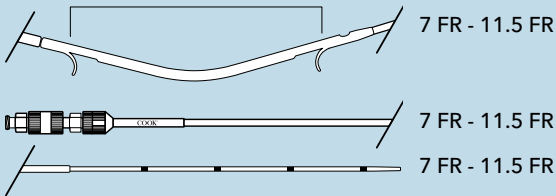

# OASIS

preloaded with ST-2 Sohendra-Tannenbaum  
Biliary Stents

	8.5 FR	10 FR	11.5 FR
5 cm	OATS-8.5-5 G26846	OATS-10-5 G26858	OATS-11.5-5 G26836
7 cm	OATS-8.5-7 G26848	OATS-10-7 G26859	OATS-11.5-7 G26837
9 cm	OATS-8.5-9 G26849	OATS-10-9 G26860	OATS-11.5-9 G26838
12 cm	OATS-8.5-12 G26853	OATS-10-12 G26863	OATS-11.5-12 G26842
15 cm	OATS-8.5-15 G26854	OATS-10-15 G26864	OATS-11.5-15 G26843

Components available separately.

## OATS

Length measured.

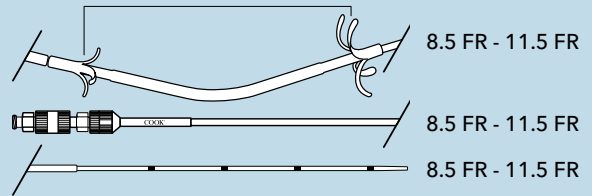

## BILIARY



# ST-2 Tannenbaum<sup>®</sup>

BILIARY STENT

The Teflon<sup>®</sup> stent material in our ST-2 Soehendra-Tannenbaum Stent is formulated to enhance patency with low surface friction to optimize flow.

- Gentle contour facilitates proper positioning in bile duct
- Proximal and distal flap design minimizes stent migration
- Teflon material combines smoothness with pushability
- Available in a wide range of sizes

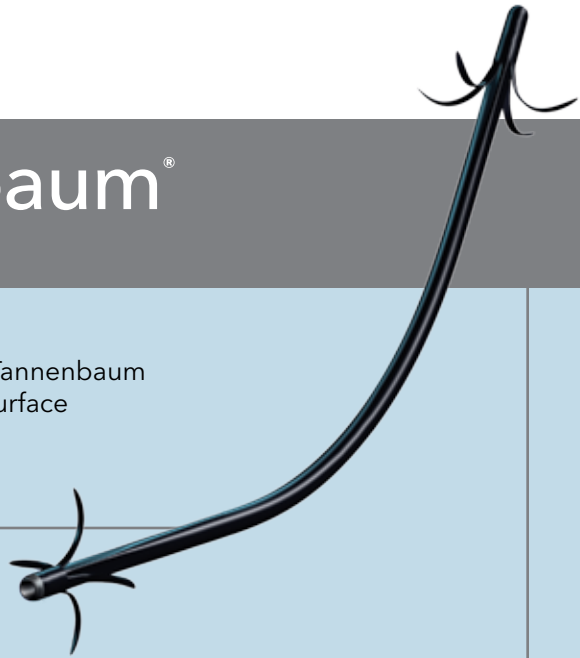
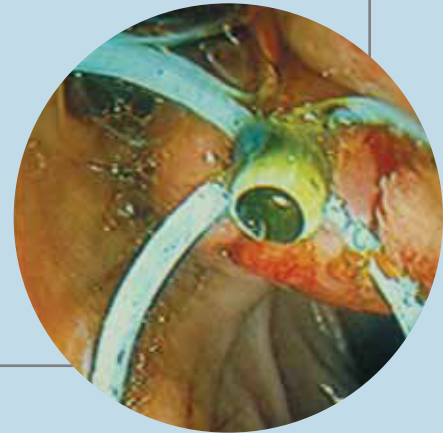

# ST-2 Soehendra-Tannenbaum Biliary Stents

	8.5 FR	10 FR	11.5 FR
5 cm	TTSO-8.5-5 G22292	TTSO-10-5 G21436	TTSO-11.5-5 G22283
6 cm	TTSO-8.5-6 G22293	TTSO-10-6 G21437	TTSO-11.5-6 G22284
7 cm	TTSO-8.5-7 G22294	TTSO-10-7 G21438	TTSO-11.5-7 G22285
8 cm	TTSO-8.5-8 G22295	TTSO-10-8 G21440	TTSO-11.5-8 G22286
9 cm	TTSO-8.5-9 G22296	TTSO-10-9 G21441	TTSO-11.5-9 G22287
10 cm	TTSO-8.5-10 G22288	TTSO-10-10 G22125	TTSO-11.5-10 G22280
11 cm	TTSO-8.5-11 G22289	TTSO-10-11 G22127	TTSO-11.5-11 G27169
12 cm	TTSO-8.5-12 G22290	TTSO-10-12 G22129	TTSO-11.5-12 G22281
13 cm	TTSO-8.5-13 G27198	TTSO-10-13 G27167	TTSO-11.5-13 G27196
14 cm	TTSO-8.5-14 G27170	TTSO-10-14 G27168	TTSO-11.5-14 G27197
15 cm	TTSO-8.5-15 G22291	TTSO-10-15 G22130	TTSO-11.5-15 G22282

Components available separately. Recommended for use with OASIS Introduction System.

## TTSO

Length measured.



8.5 FR - 11.5 FR



## BILIARY



# Solus<sup>®</sup>

## DOUBLE PIGTAIL STENT WITH INTRODUCER

The Solus Double Pigtail Stent is supple yet strong and completely radiopaque, making it an innovative solution for biliary drainage. For the ultimate in flexibility and strength, choose the Solus solution.

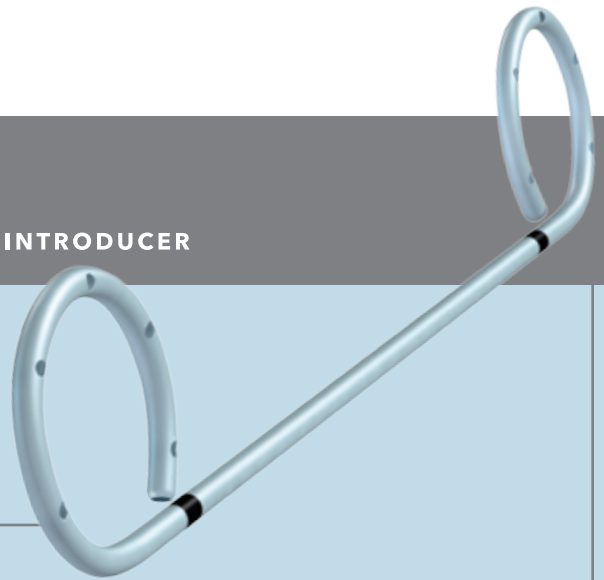

- Sof-Flex is a “soft” pliable radiopaque material that enhances fluoroscopic visibility
- Radiopaque markers enhance fluoroscopic visualization to facilitate proper positioning
- Double pigtail configuration minimizes migration
- Multiple side holes for efficient drainage
- Packaged with one-step introducer to simplify inventory management and enhance procedure efficiency



*Image courtesy of Martin Freeman, M.D., Hennepin County Medical Center, Minneapolis, MN*

# Solus Biliary Double Pigtail Stents with Introducer

10 FR

1 cm	ZSS-10-1-RB G26829
3 cm	ZSS-10-3-RB G25670
4 cm	ZSS-10-4-RB G25671
5 cm	ZSS-10-5-RB G25672
7 cm	ZSS-10-7-RB G25673
9 cm	ZSS-10-9-RB G25674
10 cm	ZSS-10-10-RB G25685
12 cm	ZSS-10-12-RB G25675
15 cm	ZSS-10-15-RB G25676

Set includes stent, pushing catheter, guiding catheter and pigtail straightener (if applicable). Recommend Tracer Metro®, sold separately.

ZSS

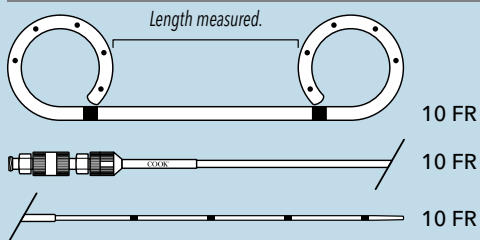

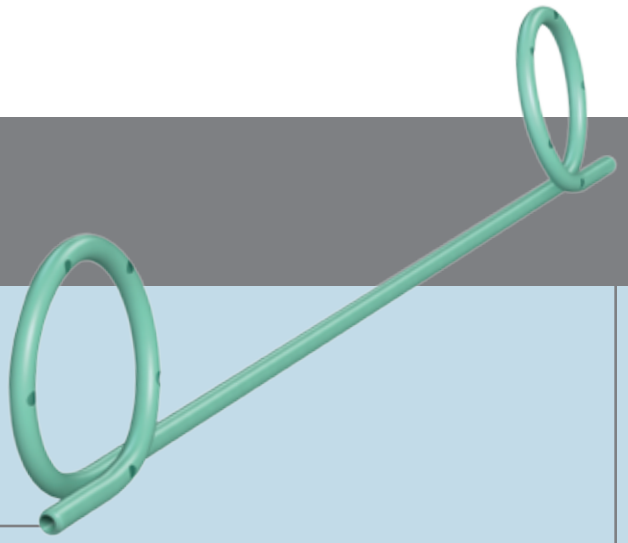

When performance is essential, choose the Zimmon Biliary Stent. This double pigtail design minimizes stent migration while side holes enhance duct drainage.

- Double pigtail configuration minimizes migration
- Tapered tip facilitates smooth cannulation
- Polyethylene material delivers pushability and softness
- Simplify inventory management and enhance procedure efficiency with stent sets, including pushing catheter



Image courtesy of Anil Sharma, M.D., Highland Hospital, Rochester, NY

## Zimmon Biliary Stents

	5 FR	6 FR	7 FR	8 FR	10 FR
2 cm					ZSO-10-2 G25399
3 cm	ZSO-5-3 G22032		ZSO-7-3 G22159		ZSO-10-3 G21973
4 cm	ZSO-5-4 G22034	ZSO-6-4 G22105	ZSO-7-4 G22161	ZSO-8-4 G21369	ZSO-10-4 G21974
5 cm	ZSO-5-5 G22036		ZSO-7-5 G22163	ZSO-8-5 G21370	ZSO-10-5 G21975
6 cm			ZSO-7-6 G22164		ZSO-10-6 G21976
7 cm	ZSO-5-7 G22038	ZSO-6-7 G22109	ZSO-7-7 G22167	ZSO-8-7 G21372	ZSO-10-7 G21977
8 cm					ZSO-10-8 G21980
9 cm	ZSO-5-9 G22040	ZSO-6-9 G22112	ZSO-7-9 G22170	ZSO-8-9 G21375	ZSO-10-9 G21982
10 cm	ZSO-5-10 G21499	ZSO-6-10 G21998	ZSO-7-10 G21707	ZSO-8-10 G21401	ZSO-10-10 G21637
12 cm	ZSO-5-12 G21501		ZSO-7-12 G21708	ZSO-8-12 G21404	ZSO-10-12 G21640
15 cm	ZSO-5-15 G22443		ZSO-7-15 G21711	ZSO-8-15 G21408	ZSO-10-15 G21645
16 cm			ZSO-7-16 G23005		
18 cm			ZSO-7-18 G23006		

Components available separately.

# Zimmon Biliary Stents continued

	5 FR	6 FR	7 FR	8 FR	10 FR	11.5 FR
2 cm			ZEBD-7-2 G22438		ZEBD-10-2 G22441	
3 cm	ZEBD-5-3 G22436		ZEBD-7-3 G22439		ZEBD-10-3 G21780	
4 cm	ZEBD-5-4 G22137	ZEBD-6-4 G22191	ZEBD-7-4 G21393		ZEBD-10-4 G21781	
5 cm	ZEBD-5-5 G22138		ZEBD-7-5 G21394	ZEBD-8-5 G21460	ZEBD-10-5 G21783	ZEBD-11.5-5 G21439
6 cm			ZEBD-7-6 G21395		ZEBD-10-6 G21785	
7 cm	ZEBD-5-7 G22140	ZEBD-6-7 G22194	ZEBD-7-7 G21396	ZEBD-8-7 G21462	ZEBD-10-7 G21787	ZEBD-11.5-7 G21442
8 cm			ZEBD-7-8 G21397		ZEBD-10-8 G21788	
9 cm	ZEBD-5-9 G22141		ZEBD-7-9 G21398	ZEBD-8-9 G22440	ZEBD-10-9 G21789	ZEBD-11.5-9 G21446
10 cm	ZEBD-5-10 G22122	ZEBD-6-10 G21795	ZEBD-7-10 G25794		ZEBD-10-10 G21862	
12 cm	ZEBD-5-12 G22437	ZEBD-6-12 G21798	ZEBD-7-12 G21526	ZEBD-8-12 G22026	ZEBD-10-12 G21864	ZEBD-11.5-12 G22207
15 cm	ZEBD-5-15 G22128		ZEBD-7-15 G21529	ZEBD-8-15 G22027	ZEBD-10-15 G21865	ZEBD-11.5-15 G22442
18 cm			ZEBD-7-18 G21530			

Set includes: Stent and 170 cm pushing catheter. Components available separately.

## ZSO

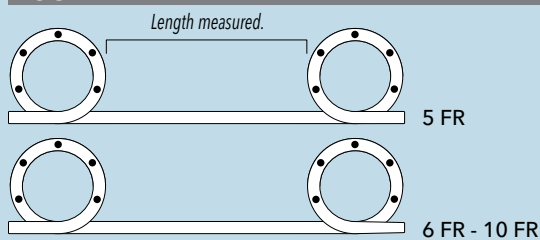

## ZEBD

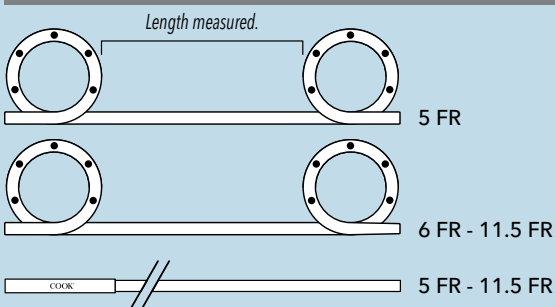



With its contoured shape and offset flaps, the Geenen Pancreatic Stent is designed for optimal positioning with a minimum of stent migration.

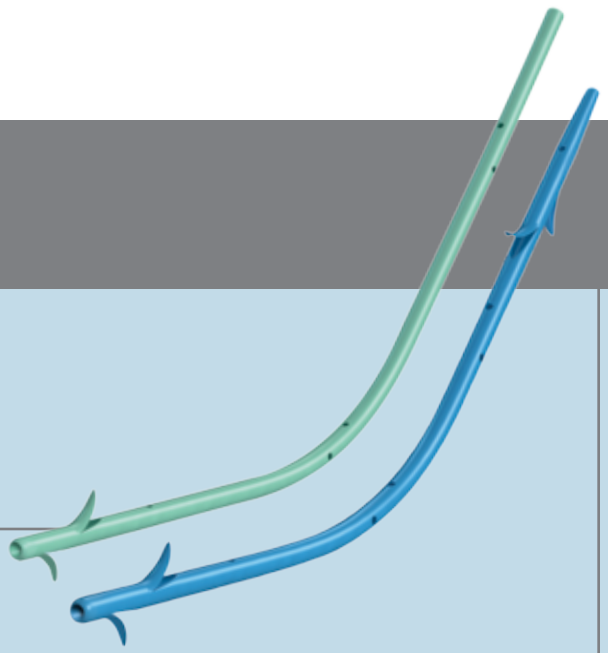

- Spiral side holes for enhanced drainage
- Tapered tip for smooth cannulation
- Contoured shape facilitates proper positioning
- Offset flaps minimize migration
- Polyethylene material delivers pushability and softness
- Simplify inventory management and enhance procedure efficiency with stent sets, including pushing catheter

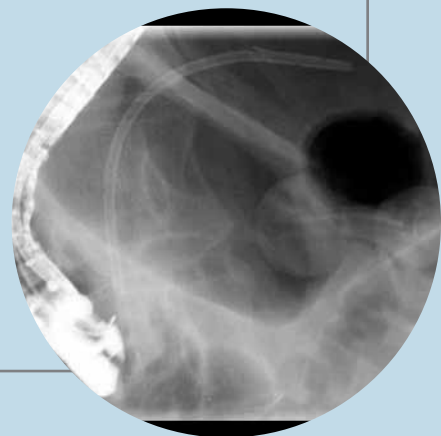

Image courtesy of Michael Gluck, M.D., Virginia Mason Medical Center, Seattle, WA

## Geenen Pancreatic Stents

	3 FR	4 FR	5 FR	6 FR	7 FR	8.5 FR	10 FR	11.5 FR
2 cm	GPSO-3-2 G27105	GPSO-4-2 G27106	GPSO-5-2 G22434	GPSO-6-2 G22467	GPSO-7-2 G22379		GPSO-10-2 G22465	
3 cm	GPSO-3-3 G27190		GPSO-5-3 G22107	GPSO-6-3 G22410	GPSO-7-3 G21371	GPSO-8.5-3 G22314	GPSO-10-3 G22319	GPSO-11.5-3 G22464
4 cm	GPSO-3-4 G24543		GPSO-5-4 G22110		GPSO-7-4 G21373			
5 cm	GPSO-3-5 G24545	GPSO-4-5 G24525	GPSO-5-5 G22111	GPSO-6-5 G22411	GPSO-7-5 G21374	GPSO-8.5-5 G22315	GPSO-10-5 G22275	GPSO-11.5-5 G22389
6 cm	GPSO-3-6 G27191		GPSO-5-6 G27162		GPSO-7-6 G21376			
7 cm	GPSO-3-7 G24523	GPSO-4-7 G24529	GPSO-5-7 G22113	GPSO-6-7 G22412	GPSO-7-7 G21377	GPSO-8.5-7 G22316	GPSO-10-7 G22320	GPSO-11.5-7 G22463
8 cm	GPSO-3-8 G27192		GPSO-5-8 G27163		GPSO-7-8 G27166			
9 cm	GPSO-3-9 G27193	GPSO-4-9 G24801	GPSO-5-9 G22114	GPSO-6-9 G22413	GPSO-7-9 G21379	GPSO-8.5-9 G22317	GPSO-10-9 G22322	GPSO-11.5-9 G22462
10 cm	GPSO-3-10 G24542		GPSO-5-10 G22097		GPSO-7-10 G21506		GPSO-10-10 G22321	
11 cm	GPSO-3-11 G27185		GPSO-5-11 G27159		GPSO-7-11 G22466			
12 cm	GPSO-3-12 G27186		GPSO-5-12 G22099	GPSO-6-12 G22401	GPSO-7-12 G21507	GPSO-8.5-12 G22318	GPSO-10-12 G22323	
13 cm	GPSO-3-13 G27187		GPSO-5-13 G27160		GPSO-7-13 G27164			
14 cm	GPSO-3-14 G27188		GPSO-5-14 G27161		GPSO-7-14 G27165			
15 cm	GPSO-3-15 G27189		GPSO-5-15 G22102	GPSO-6-15 G24546	GPSO-7-15 G21509	GPSO-8.5-15 G22986	GPSO-10-15 G22987	GPSO-11.5-15 G24541
18 cm			GPSO-5-18 G24802		GPSO-7-18 G22984			
20 cm					GPSO-7-20 G22985			

Set Includes: Stent, 170 cm pushing catheter and 320 cm guiding catheter. Components available separately. Recommend .018 Roadrunner® wire guide for 3 FR stents. Recommend Tracer Metro® Direct for all others.

# Geenen Pancreatic Stents continued

	3 FR	5 FR	7 FR	8.5 FR	10 FR	11.5 FR
2 cm		GEPD-5-2 G22478				
3 cm	GEPD-3-3 G24552	GEPD-5-3 G22206	GEPD-7-3 G21475	GEPD-8.5-3 G22475	GEPD-10-3 G22276	
4 cm	GEPD-3-4 G27180	GEPD-5-4 G22208	GEPD-7-4 G21476			
5 cm	GEPD-3-5 G27181	GEPD-5-5 G22209	GEPD-7-5 G21478	GEPD-8.5-5 G22277	GEPD-10-5 G21851	
6 cm	GEPD-3-6 G27149	GEPD-5-6 G22477	GEPD-7-6 G27157			GEPD-11.5-6 G22470
7 cm	GEPD-3-7 G27182	GEPD-5-7 G22210	GEPD-7-7 G21479	GEPD-8.5-7 G22474	GEPD-10-7 G22472	
8 cm	GEPD-3-8 G27183	GEPD-5-8 G22476	GEPD-7-8 G27158			GEPD-11.5-8 G22469
9 cm	GEPD-3-9 G27184	GEPD-5-9 G22212	GEPD-7-9 G21480	GEPD-8.5-9 G22473	GEPD-10-9 G22471	
10 cm	GEPD-3-10 G27174	GEPD-5-10 G27150	GEPD-7-10 G21572			GEPD-11.5-10 G22468
11 cm	GEPD-3-11 G27175	GEPD-5-11 G27151	GEPD-7-11 G27154			
12 cm	GEPD-3-12 G27176	GEPD-5-12 G22189	GEPD-7-12 G21575	GEPD-8.5-12 G24540	GEPD-10-12 G22487	GEPD-11.5-12 G22386
13 cm	GEPD-3-13 G27177	GEPD-5-13 G27152	GEPD-7-13 G27155			
14 cm	GEPD-3-14 G27178	GEPD-5-14 G27153	GEPD-7-14 G27156			
15 cm	GEPD-3-15 G27179	GEPD-5-15 G22190	GEPD-7-15 G21578		GEPD-10-15 G22488	

Set Includes: Stent, 170 cm pushing catheter and 320 cm guiding catheter. Components available separately.  
 Recommend .018 Roadrunner® wire guide for 3 FR stents. Recommend Tracer Metro® Direct for all others.

	5 FR	7 FR		5 FR	7 FR
2 cm	GPSOS-5-2 G22460	GPSOS-7-2 G22459	2 cm	GPDS-5-2 G22461	
3 cm	GPSOS-5-3 G21513	GPSOS-7-3 G21592	3 cm	GPDS-5-3 G21802	GPDS-7-3 G21898
4 cm	GPSOS-5-4 G21514		5 cm	GPDS-5-5 G21803	GPDS-7-5 G21899
5 cm	GPSOS-5-5 G21515	GPSOS-7-5 G21594	7 cm	GPDS-5-7 G21804	GPDS-7-7 G21901
7 cm	GPSOS-5-7 G21517	GPSOS-7-7 G21595	9 cm	GPDS-5-9 G21806	GPDS-7-9 G21902
9 cm	GPSOS-5-9 G21519	GPSOS-7-9 G21597	12 cm	GPDS-5-12 G21723	GPDS-7-12 G21939
10 cm		GPSOS-7-10 G21856	15 cm	GPDS-5-15 G21724	
12 cm	GPSOS-5-12 G21633	GPSOS-7-12 G21858	<i>Components available separately.</i>		
15 cm	GPSOS-5-15 G21636	GPSOS-7-15 G25073			

Components available separately.

## GPSO

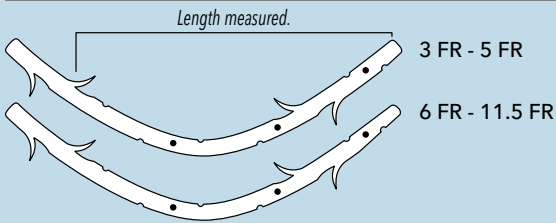

## GPSOS

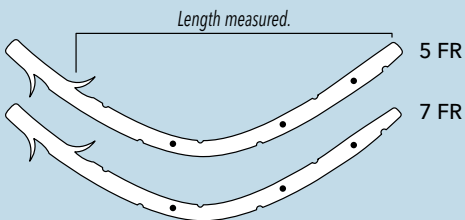

## GEPD

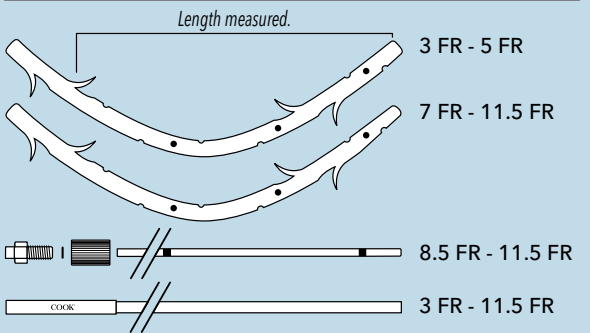

## GPDS

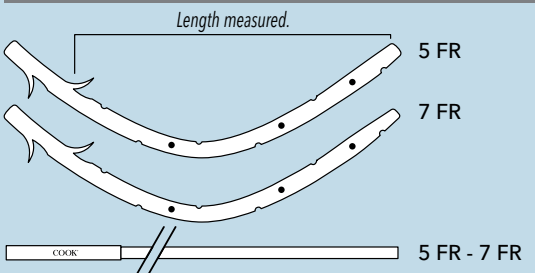

## PANCREATIC

**COOK**  
MEDICAL

# Geenen<sup>®</sup>

SOF-FLEX<sup>®</sup> PANCREATIC STENT

The Geenen Sof-Flex Pancreatic Stent, made of a strong yet flexible material, is designed to gently take the shape of the duct instead of forcing the duct to take the shape of the stent. Available with and without internal ductal flaps to meet all of your clinical needs.

- Spiral side holes for enhanced drainage
- Contoured shape facilitates proper positioning
- Offset flaps minimize migration
- Sof-Flex is a “soft” pliable radiopaque material that enhances fluoroscopic visibility

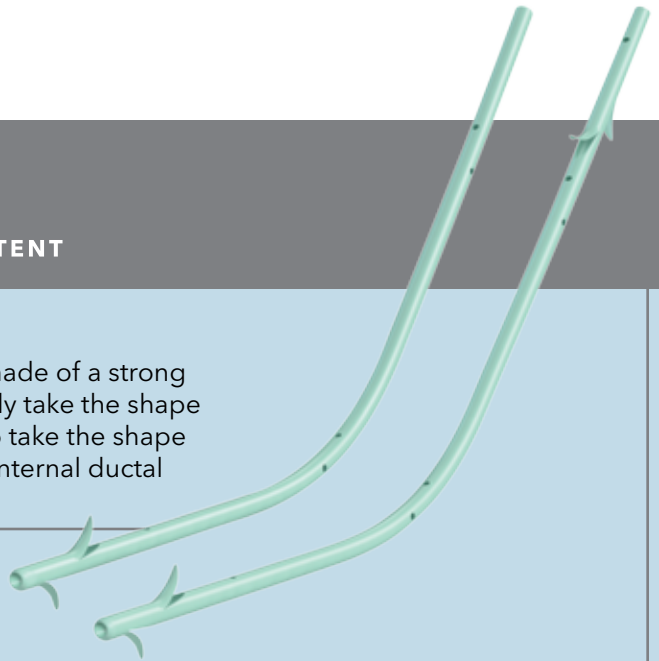

*Image courtesy of Irving Waxman, M.D., University of Chicago, Chicago, IL*

# Geenen Sof-Flex Pancreatic Stents

	5 FR
--	------

3 cm	GPSO-SF-5-3 G49663
5 cm	GPSO-SF-5-5 G49664
7 cm	GPSO-SF-5-7 G49665
9 cm	GPSO-SF-5-9 G49666
12 cm	GPSO-SF-5-12 G49667

Components available separately. Recommend Tracer Metro® Direct, sold separately.

	5 FR
--	------

3 cm	GPSOS-SF-5-3 G49668
5 cm	GPSOS-SF-5-5 G49669
7 cm	GPSOS-SF-5-7 G49670
9 cm	GPSOS-SF-5-9 G49671
12 cm	GPSOS-SF-5-12 G49672

Components available separately. Recommend Tracer Metro® Direct, sold separately.

## GPSO-SF

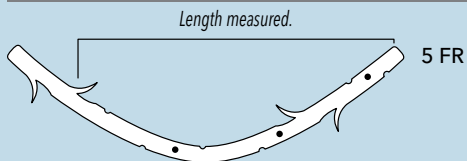

## GPSOS-SF

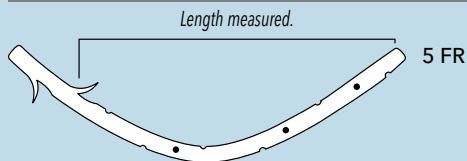



## PANCREATIC



# Johlin™

## PANCREATIC WEDGE STENT

Designed to conform to the duct instead of forcing the duct to conform to the stent, Johlin Pancreatic Wedge Stents are made of flexible, yet strong Sof-Flex material. Available in a variety of sizes and can be smoothly delivered with the Wedge Stent Introducer.

- Sof-Flex is a “soft” pliable radiopaque material that enhances fluoroscopic visibility
- Wedge shaped distal end facilitates entrance into duct and minimizes stent migration
- Drainage holes allow drainage of lateral branches of the pancreatic duct
- Includes Wedge Stent Introducer, designed specifically for the Johlin Stent

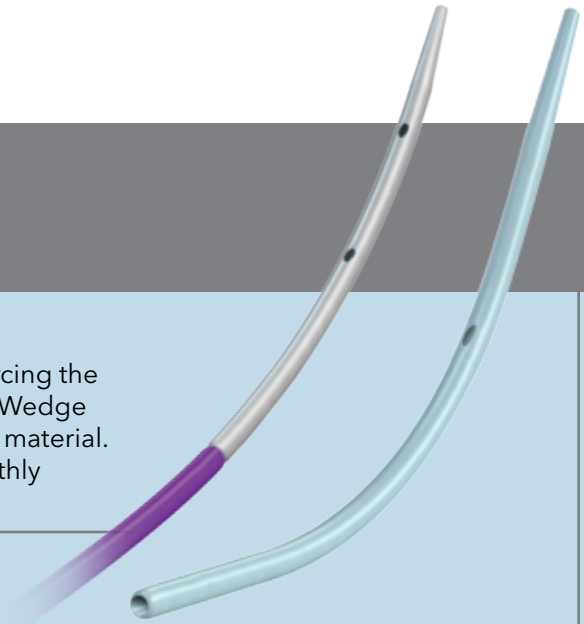
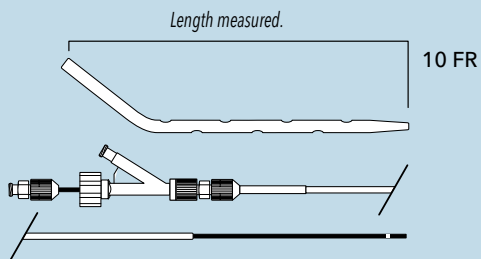
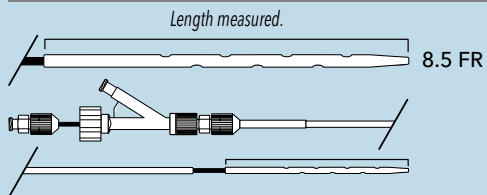

*Image courtesy of Amrita Sethi, M.D., Columbia University Medical Center, New York, NY*

# Johlin Pancreatic Wedge Stents

	8.5 FR	10 FR
8 cm	JPWS-8.5-8 G25694	JPWS-10-8 G25713
10 cm	JPWS-8.5-10 G25695	JPWS-10-10 G25714
12 cm	JPWS-8.5-12 G25693	JPWS-10-12 G25715
14 cm	JPWS-8.5-14 G25691	JPWS-10-14 G25716
16 cm	JPWS-8.5-16 G25690	JPWS-10-16 G25717
18 cm	JPWS-8.5-18 G26830	JPWS-10-18 G26825
20 cm	JPWS-8.5-20 G26831	JPWS-10-20 G26827
22 cm	JPWS-8.5-22 G26832	JPWS-10-22 G26828

## JPWS



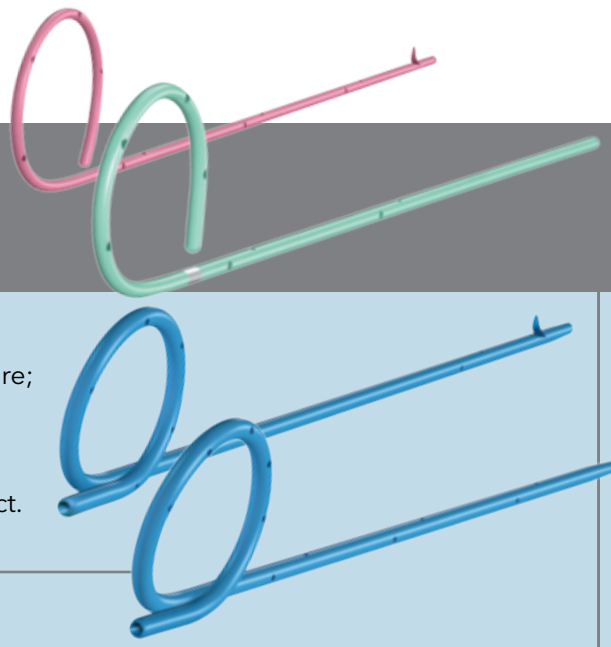

The pancreatic duct demands specialized care; Zimmon Pancreatic Stents are uniquely designed to meet these specific needs. The pigtail retention flap stent design aids in maintaining its position in the pancreatic duct.

- Duodenal pigtail (and optional ductal flap) to minimize migration
- Spiral side holes (optional) for enhanced drainage
- Tapered tip for smooth cannulation
- Radiopaque marker facilitates proper positioning
- Polyethylene material delivers pushability and softness
- Available in a variety of French sizes to meet specific procedural needs



### Zimmon Pancreatic Stents

	4 FR	5 FR	6 FR	7 FR	8.5 FR	10 FR
2 cm	SPSOF-4-2 G24571	SPSOF-5-2 G22357	SPSOF-6-2 G22364	SPSOF-7-2 G22350		
2.5 cm		SPSOF-5-2.5 G22376	SPSOF-6-2.5 G22377	SPSOF-7-2.5 G22378		
3 cm		SPSOF-5-3 G22979		SPSOF-7-3 G22454		SPSOF-10-3 G22975
4 cm	SPSOF-4-4 G24575	SPSOF-5-4 G22358	SPSOF-6-4 G22365	SPSOF-7-4 G22351		SPSOF-10-4 G22976
5 cm		SPSOF-5-5 G22980		SPSOF-7-5 G22455		SPSOF-10-5 G24589
6 cm	SPSOF-4-6 G24579	SPSOF-5-6 G22359	SPSOF-6-6 G22366	SPSOF-7-6 G22352		SPSOF-10-6 G22977
7 cm		SPSOF-5-7 G22360		SPSOF-7-7 G22353	SPSOF-8.5-7 G24590	SPSOF-10-7 G24591
8 cm	SPSOF-4-8 G24582	SPSOF-5-8 G22361	SPSOF-6-8 G22367	SPSOF-7-8 G22354		SPSOF-10-8 G24707
9 cm		SPSOF-5-9 G22981		SPSOF-7-9 G22456		
10 cm	SPSOF-4-10 G24569	SPSOF-5-10 G22362	SPSOF-6-10 G22368	SPSOF-7-10 G22355	SPSOF-8.5-10 G24593	SPSOF-10-10 G22982
11 cm		SPSOF-5-11 G27194		SPSOF-7-11 G27195		
12 cm	SPSOF-4-12 G50281	SPSOF-5-12 G22363	SPSOF-6-12 G22369	SPSOF-7-12 G22356	SPSOF-8.5-12 G24594	SPSOF-10-12 G24592
15 cm	SPSOF-4-15 G50282	SPSOF-5-15 G22978	SPSOF-6-15 G24584	SPSOF-7-15 G22983		SPSOF-10-15 G24585
18 cm	SPSOF-4-18 G26839			SPSOF-7-18 G24586		

Set Includes: Stent, 170 cm pushing catheter and 320 cm guiding catheter (if applicable). Components available separately.

# Zimmon Pancreatic Stents continued

3 FR			5 FR			7 FR			5 FR			7 FR		
3 cm		SPSOS-5-3 G24570		SPSOS-7-3 G24587		2 cm	ZPSOF-5-2 G22071		ZPSOF-7-2 G22184		3 cm	ZPSOS-5-3 G22453		
4 cm	SPSOS-3-4-N G24566					3 cm	ZPSOF-5-3 G22375				4 cm		ZPSOS-7-4 G21953	
5 cm		SPSOS-5-5 G24574		SPSOS-7-5 G24588		4 cm	ZPSOF-5-4 G22073		ZPSOF-7-4 G22186		5 cm	ZPSOS-5-5 G22457		
6 cm	SPSOS-3-6-N G24567					5 cm	ZPSOF-5-5 G22448				6 cm		ZPSOS-7-6 G21955	
7 cm		SPSOS-5-7 G24578				6 cm	ZPSOF-5-6 G22075		ZPSOF-7-6 G22187		7 cm	ZPSOS-5-7 G21849		
8 cm	SPSOS-3-8-N G24568					7 cm	ZPSOF-5-7 G22076		ZPSOF-7-7 G22451		8 cm		ZPSOS-7-8 G21956	
10 cm	SPSOS-3-10-N G24564					8 cm	ZPSOF-5-8 G22077		ZPSOF-7-8 G22188		9 cm	ZPSOS-5-9 G22458		
12 cm	SPSOS-3-12-N G24565					9 cm	ZPSOF-5-9 G22449		ZPSOF-7-9 G22452		10 cm		ZPSOS-7-10 G21638	
18 cm	SPSOS-3-18-N G26847					10 cm	ZPSOF-5-10 G21827				12 cm	ZPSOS-5-12 G21419	ZPSOS-7-12 G21642	
						12 cm	ZPSOF-5-12 G21828				25 cm		ZPSOS-7-25-NP G24610	
						15 cm	ZPSOF-5-15 G22450							

Set Includes: Stent, 170 cm pushing catheter and 320 cm guiding catheter (if applicable). Components available separately.

Components available separately.

Components available separately.

5 FR			7 FR		
2 cm	ZEPDF-5-2 G22162		ZEPDF-7-2 G21425		
4 cm	ZEPDF-5-4 G22165		ZEPDF-7-4 G21426		
5 cm	ZEPDF-5-5 G22444		ZEPDF-7-5 G22446		
6 cm	ZEPDF-5-6 G22169		ZEPDF-7-6 G21427		
7 cm	ZEPDF-5-7 G22171		ZEPDF-7-7 G22447		
8 cm	ZEPDF-5-8 G22173		ZEPDF-7-8 G21428		
9 cm	ZEPDF-5-9 G22445		ZEPDF-7-9 G21429		
10 cm	ZEPDF-5-10 G22115		ZEPDF-7-10 G21522		
12 cm	ZEPDF-5-12 G22116		ZEPDF-7-12 G21524		
15 cm			ZEPDF-7-15 G24563		

5 FR			7 FR		
2 cm	ZEPDS-5-2 G21920				
4 cm	ZEPDS-5-4 G21923		ZEPDS-7-4 G22041		
6 cm	ZEPDS-5-6 G21924		ZEPDS-7-6 G22042		
8 cm	ZEPDS-5-8 G21926		ZEPDS-7-8 G22045		
10 cm	ZEPDS-5-10 G21689		ZEPDS-7-10 G21893		
12 cm	ZEPDS-5-12 G21691		ZEPDS-7-12 G21895		

Components available separately.

Components available separately.

## SPSOF

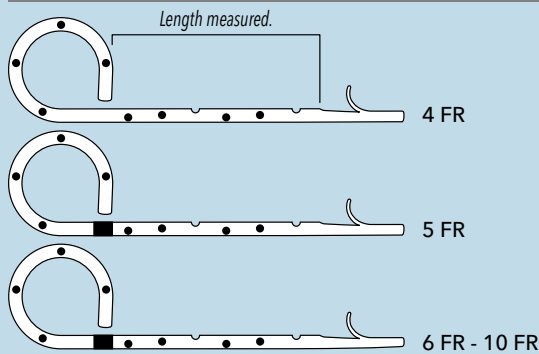

## SPSOS

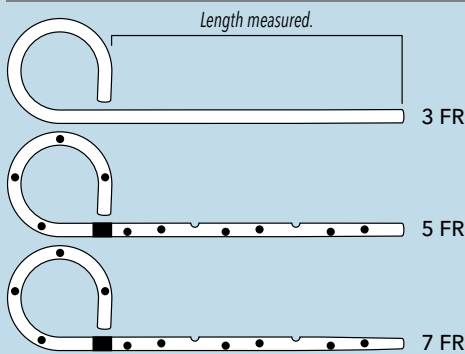

## ZPSOF

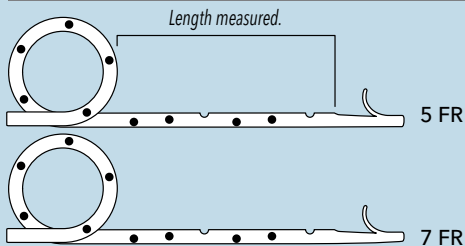

## ZPSOS

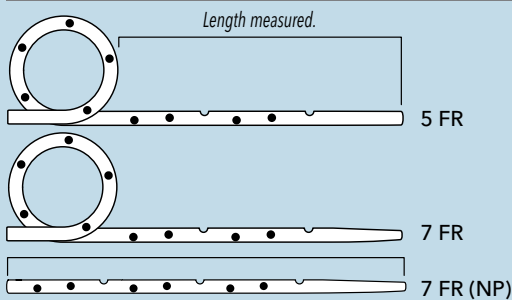

## ZEPDF

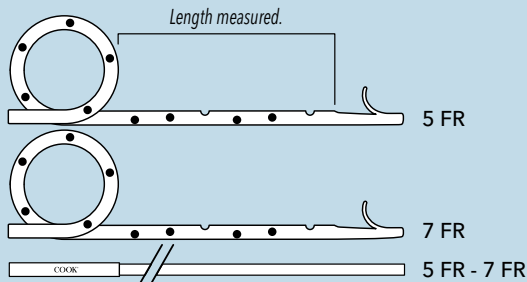

## ZEPDS

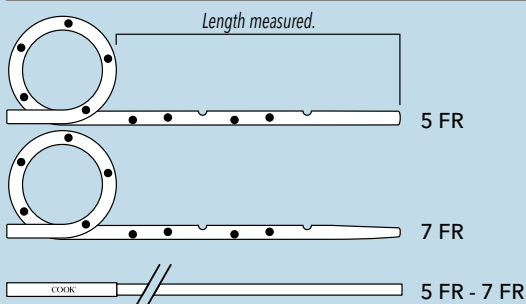



[www.cookmedical.com](http://www.cookmedical.com)

#### **COOK ENDOSCOPY**

4900 Bethania Station Road, Winston-Salem, NC 27105 U.S.A.

Phone: 336 744-0157, Toll Free: (USA) 800 457-4500, Fax: 336 744-5231

Johlin is a trademark of Cook Endoscopy.

Cotton-Huibregtse, Cotton-Leung, Fusion, Geenen, Marathon, OASIS, Roadrunner, Sof-Flex, Solus, ST-2 Soehendra-Tannenbaum, Tracer Metro and Zimmon are registered trademarks of Cook Endoscopy.

Cook is a registered trademark of Cook Incorporated.

© 2010 Cook Medical

L-12343/0310